

KISSLING SINGLE POLE POWER RELAYS

Series 29 / 300A - from TE Connectivity (TE)

The economical 29 series single coil relays with 300 amps (A) are developed using our competence and expertise gathered over decades of manufacturing to meet even the most demanding operating requirements.

This single coil system relay features high shock and vibration resistance predominantly from its careful design and an optimized magnetic circuit. The sealing technology used in these relays meets both the IP67 and IP6K9K (Steam pressure cleaning) protection standard. This relay series is well suited for various applications in severe conditions.

Other important advantages are low heat generation in the contact area based on low contact voltage drop, a compact design, low holding current, silver alloy contact material and the use of mechanical and high thermal stability insulating compounds. Both the terminals and the housing are protected against corrosion.

By equipping these relays with blow-out magnets, contact voltages are also achievable up to 250VDC. The use of blow-out magnets are also recommended for contact voltages over 40VDC and for inductive load applications to maintain long contact life at all voltages.

Also available are various bracket styles to meet your installation conditions and suppression devices to eliminate electromagnetic interference at the coil and optional auxiliary contacts.

Features

- Sealed housing conforms to IP6K9K
- Robust design
- Minimized coil current
- Variety of configuration options
- 6G shock and 4G vibration resistant
- Main contact current rated for continuous current and 100% duty cycle
- Efficient coil and magnetic circuit design with switching properties and holding current requirements

Applications

- Truck
- Bus
- Ground support vehicles
- Construction and agricultural vehicles
- Fork lift applications

Circuits

NO-Contact

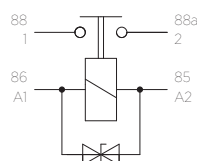

Suppression diode

NC-Contact

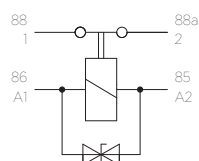

Suppression diode

NO/NC-Contact

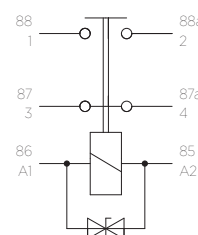

Suppression diode

NO-Contact/Auxiliary-Contact

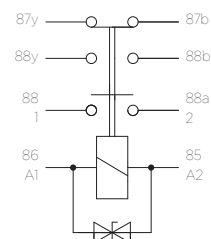

Suppression diode

SERIES 29

300A

Specification

Technical Data

Temperature range	-40°C to +85°C
Protection	IEC 60529 & DIN 40050-9 - IP67 (0,2bar, 1min) and IP6K9K
Shock	6g / 11msec
Vibration	4g / 50-2000Hz
Thread sizes / Torque	M4 = 2.0 - 2.2Nm M10 = 15 - 20Nm

Electrical Characteristics

Min. Insulation resistance	100MΩ
After live or environment	50MΩ
Dielectric withstanding voltage	1050VAC / 1min at 50Hz
Max. Contact drop, initial	150mV
Contact drop after life test	175mV
Continuous current	300A
Overload	2400A - 1sec / 600A - 20sec

Rated contact load	12 / 24 / 28VDC	48VDC	60VDC	80VDC
Resistive load	300A	300A	300A	200A
Cycles	200.000	100.000	50.000	100.000
Mechanical life	2.000.000 cycles	2.000.000 cycles	2.000.000 cycles	2.000.000 cycles

Coil Data	12VDC	24 / 28VDC	48VDC	60VDC	80VDC
Voltage range	9-16VDC	18-32VDC	36-54VDC	45-68VDC	60-90VDC
Nominal voltage	12VDC	28VDC	48VDC	60VDC	80VDC
Pick up voltage max.	9VDC	18VDC	36VDC	45VDC	60VDC
Drop out voltage min.	≤ 2VDC	≤ 4VDC	≤ 8VDC	≤ 10VDC	≤ 20VDC
Coil resistance	15Ω ± 10%	62Ω ± 10%	245Ω ± 10%	370Ω ± 10%	660Ω ± 10%
Coil current approx.	1A	0.40A	0.20A	0.18A	0.12A
Coil power approx.	10W	10W	10W	10W	10W

Operating times NO-Contact relay

Operate	max. 40msec
Bounce	max. 5msec
Release	max. 20msec
Wire Section	min. 95mm ² / 0.147 sq.inch / AWG 4-0
Mounting position	optional

Technical drawings

Standard side mounting

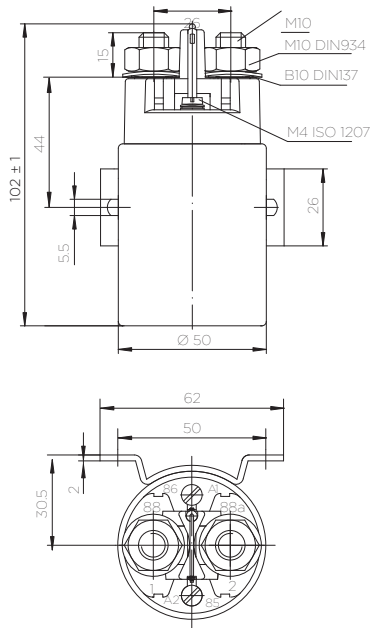

Short form side mounting

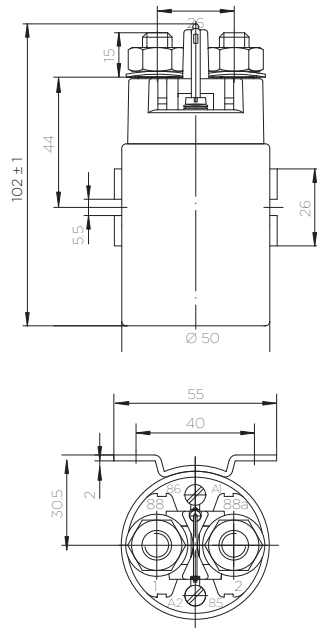

Long form side mounting

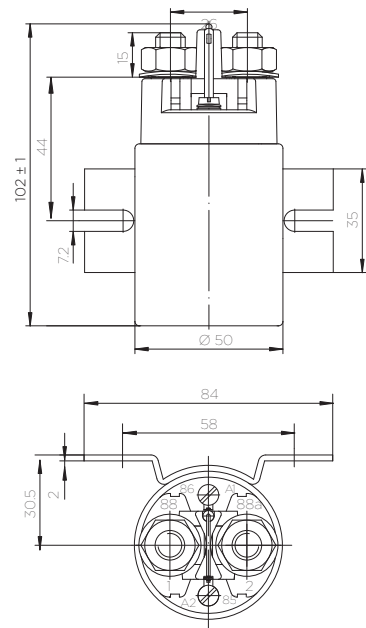

Bottom mounting

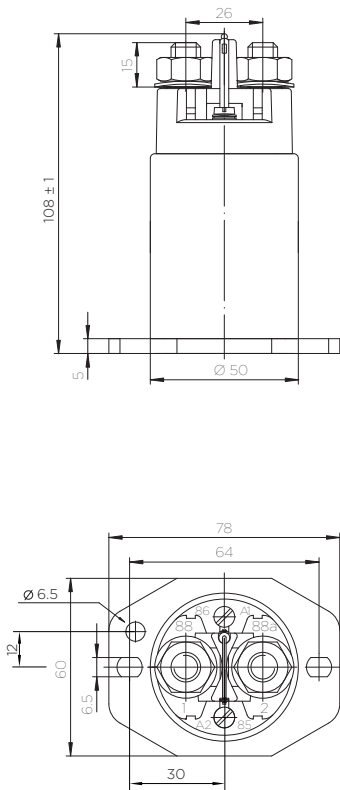

Change-over NO/NC

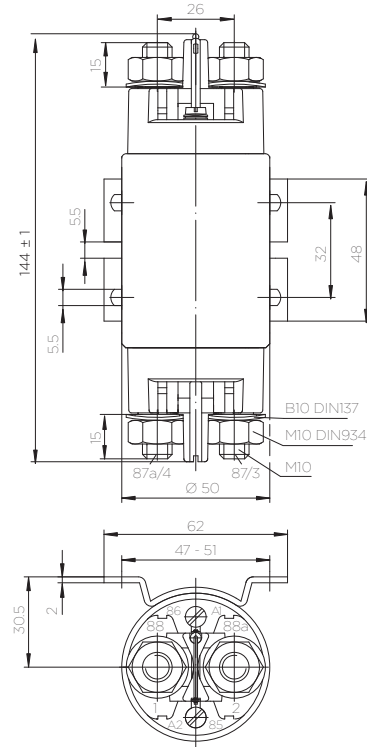

Options:

Auxiliary contacts, magnetic blowouts

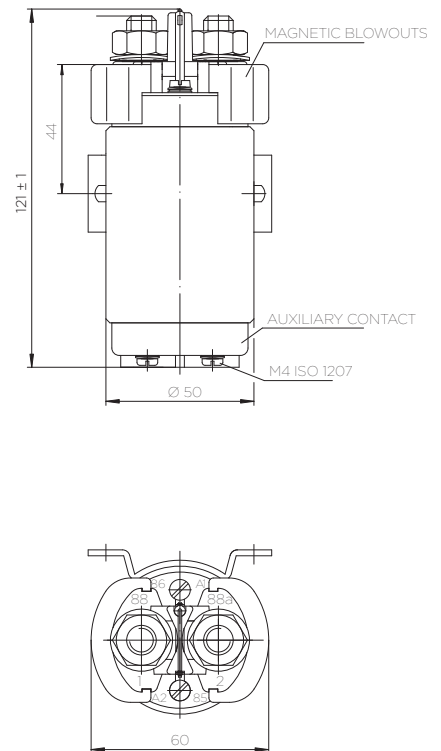

Ordering Information

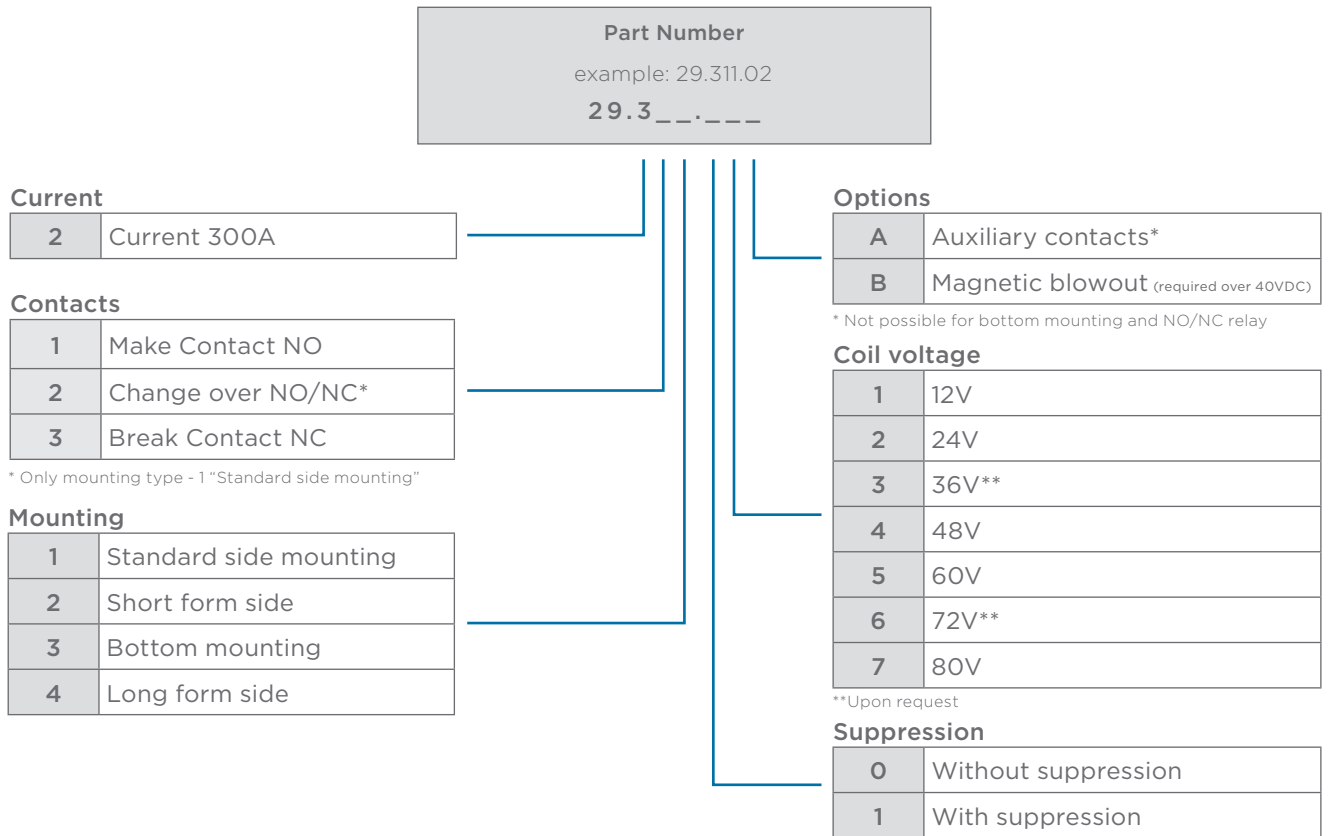

te.com

TE Connectivity, TE, TE connectivity (logo), KISSLING (logo) and KISSLING (word) are trademarks owned or licensed by the TE Connectivity family of companies. All other logos, products and/or company names referred to herein might be trademarks of their respective owners.

The information given herein, including drawings, illustrations and schematics which are intended for illustration purposes only, is believed to be reliable. However, TE Connectivity makes no warranties as to its accuracy or completeness and disclaims any liability in connection with its use. TE Connectivity's obligations shall only be as set forth in TE Connectivity's Standard Terms and Conditions of Sale for this product and in no case will TE Connectivity be liable for any incidental, indirect or consequential damages arising out of the sale, resale, use or misuse of the product. Users of TE Connectivity products should make their own evaluation to determine the suitability of each such product for the specific application.